

1020-6



INSTALLATION INSTRUCTIONS

Step1: Drill Holes in Wall for screws or screw anchors

Determine your desired location for installation .Make a mark on the wall where each mounting screw will be placed as shown below. Making sure unit is level. Drill a hole on each mark.

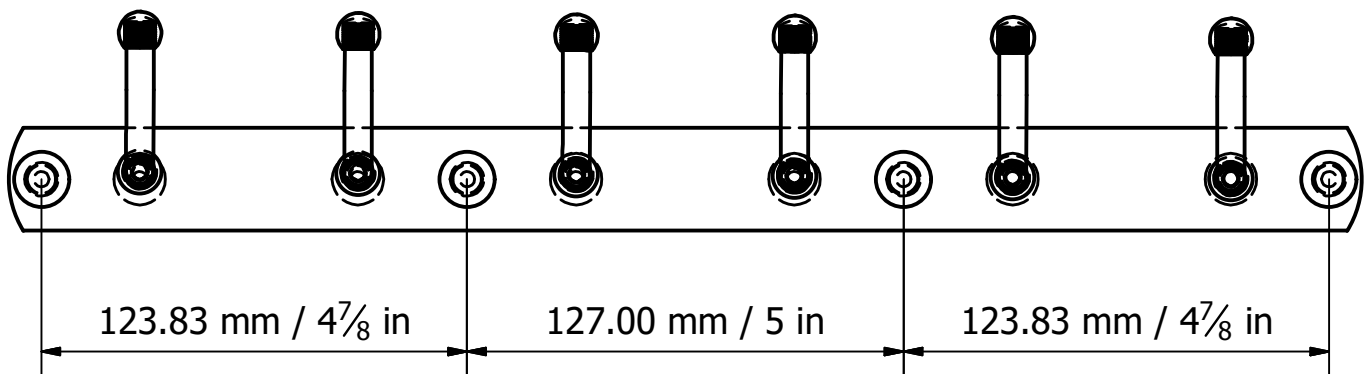

Step2: Attach unit to Mounting Surface.

